

Silicone sealing profiles

Q-Similar	A	B	C	Item code
	14	1,5	11	9066
	23	2,5	9	11357
	25	2	15	6525
	26	2	11	6069
	28	2,2	15	6694
	28	2,2	15	6694
	29	2	19	5783
	30	2	15	9421
	30	2,2	14	10288
	30	3	13	9699
	30	2,2	12	12050
	30	3	10	11288
	31	3	16	5546
	36	3	23	11034
	36	2	18	6203
	38	2	12	8225
	39	2,2	17	15038
	42	2,6	15	12224
	50	2	30	9843
	50	5	30	10108
	55	6	20	12135
	70	2	20	11267

Examples of complex profile configurations:

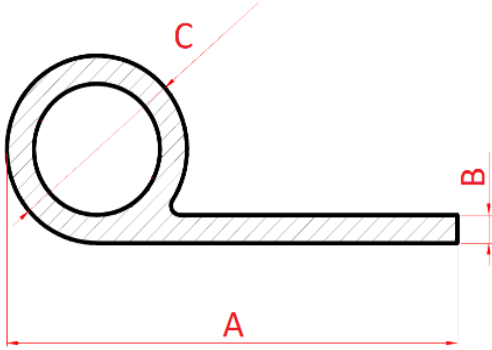
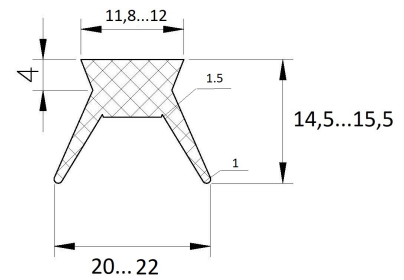
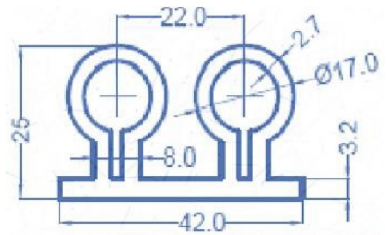
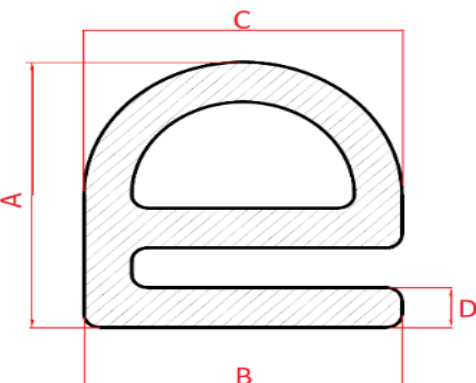

E-Similar	A	B	C	D	Item code
	11	13		3	5497
	12	16	16	2	8385
	12	13			5556
	12,5		14		11622
	12,5	9,3		2	12477
	13	18	18	1,5	11162
	14	18,3	18,3	2,5	12493
	15	18	18	1	5432
	15	20	18	2	5866
	16	21	21	2	11259
	16	20	16	2,5	11482
	16	19	19		5875
	16		19		5875
	17	21	21	2	610
	18	21	21	2	7265
	18	26	25	2	11760
	18	18	18	2,2	12498
	18	15	12		13647
	19	21	19	2	7150
	19	19	19		5918
	20	20	20	2,5	6840
	21	25	25	2,5	10986
	24	23	21	2,9	10836
	24	21	18		5403
	25	20	20	2	5433
	27	20	27	3	13091
	29	24	23	4	8268
	40	25	25	3	8950

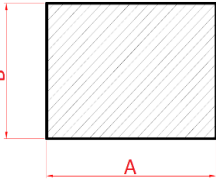
Rectangle	A	B	Item code		A	B	Item code
	1	20	8861		8	15	10619
	1	25	14438		8	16	8777
	1,5	5	7819		8	17	7392
	1,5	30	12142		8	22	11206
	2	3	8333		8	35	8829
	2	10	12722		8	40	8869
	2	20	10510		9	15	14545
	2	30	10910		9	20	11610
	2,5	22	11940		9	25	6938
	2,5	30	13436		9	34	10620
	3	6	11258		10	10	5533
	3	7	7486		10	12	6038
	3	10	14435		10	14	6681
	3	15	8870		10	15	5615
	3	16	9847		10	16	6473
	3	30	7901		10	17	7438
	3	40	10275		10	20	5573
	3	45	8322		10	22	7262
	3	60	10043		10	23	5102
	3	70	14763		10	24	6910
	3,5	14	5608		10	25	13452
	4	4	5927		10	45	9401
	4	6	13944		10	60	6128
	4	7	5511		11	11	3391
	4	8	7474		12	12	7857
	4	10	14436		12	14	7406
	4	13	11994		12	15	8064
	4	20	8562		12	16	14792
	4	30	10344		12	18	1715
	4	40	5099		12	20	12384
	4	45	7747		12,5	12,5	10302
	4	50	7068		13	13	10198
	4	60	5765		13	14	5753
	5	8	10099		13	17	10838
	5	10	6181		14	14	5564
	5	15	9614		14	16	7460
	5	20	5493		14	24	12740
	5	40	7350		15	15	6013
	5	50	7820		15	18	10467
	5	60	7337		15	20	13940
	6	6	3236		15	30	8539
	6	8	13106		15	40	6064
	6	9	14965		15	45	12399
	6	10	7228		16	16	5622
	6	11	14687		16	20	6098
	6	14	12009		16	25	10459
	6	16	10632		16	18	13062
	6,2	15	10618		16	19	5431
7	14	9480		18	18	13732	
7	69	9831		19	19	10642	
7,5	18	6188		20	24	6560	
8	8	2517		20	35	9324	
8	9	10968		20	25	14232	
8	10	12757		23	25	14339	
8	12	10341		28	30	7505	
8	14	10772		30	35	7504	

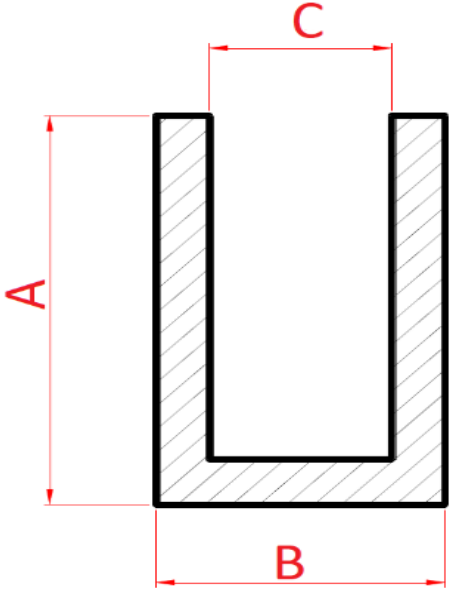
U-Similar	A	B	C	Item code
	7	10	3	5959
	7	11	7	11266
	7	5	3	9192
	8	3,4	1	8577
	8	8	4	8171
	9	5,5	1,5	6043
	10	10	2	12113
	10	5	2	13242
	11	12	6	8355
	11,8	7	3	9895
	12	8	2	5553
	12	25	4	15156
	14	6	2	6619
	15	8	1	7862
	16	27	23	8862
	17,5	27	14,5	9174
	18	28	24	6186
	19	12	5	8792
	20	13	5	13922
	20	10	5	11962
	20	10	4	12344
	20	14	2	14406
	20	18	8	14369
	20	7,5	3	11831
	20	25	19	5543
	24	10	6	8657
	25	12	6	9695
	25	47	27	7072
	27	9	3	7157
	30	20	9,5	15000
	31	15	6	11567
	36	36	30	9661
	42	50	40	7401
	42	48	40	7384
	50	50	40	7362
	51	27	15	7426

Examples of complex profile configurations:

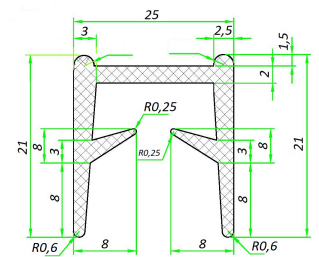
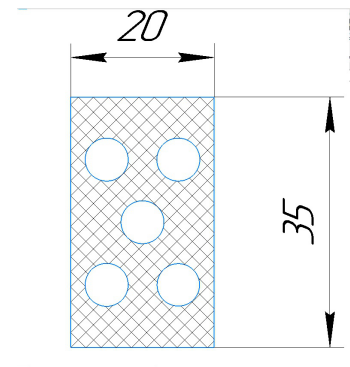
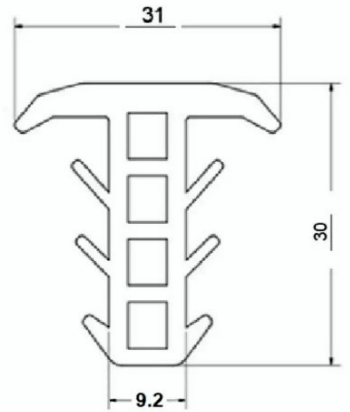

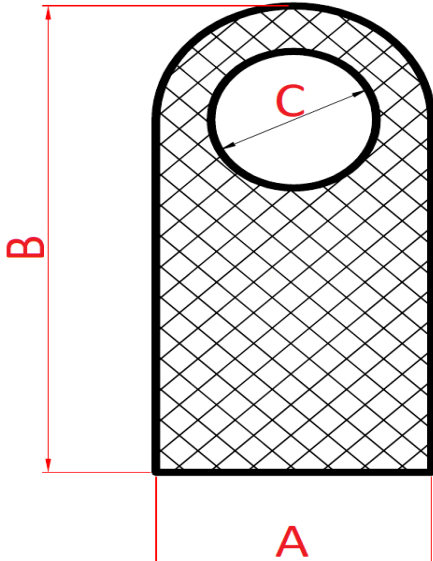

Rounded with hole	A	B	C	Item code
	7,5	10	3	13443
	8	15	4	12063
	8	7	4	9651
	11	25	6	10710
	11,5	24	8	12544
	12	17	4	5841
	13	20	10	8025
	14	25	8	6839
	14	25	5	10680
	15	18	6	12503
	15	16		9159
	16	30	10	7456
	17	21		9256
	18	21	7	10175
	20	21	6	6042
	20	30	10	12485
	20	22	5	11626

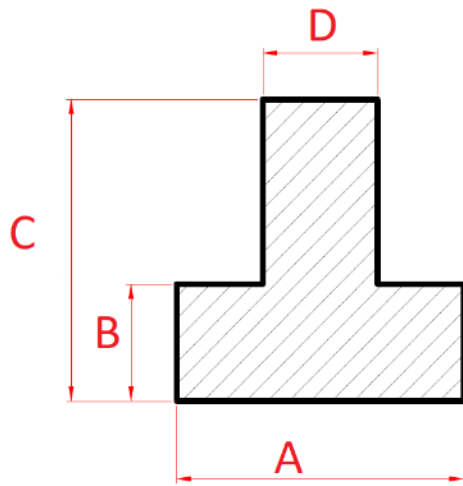
T-Similar

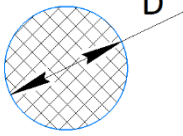

A	B	C	D	Item code
2,5		5	1	9232
3	2	6	1,5	12545
4	3,5	6,5	2,2	5473
4	2	6	2,5	9353
4	1,5	5	2	13626
4	2,2	6	2,2	14631
4,2	2,2	5,2	2,2	8579
4,7	2,6	7,8	2,1	13138
4,7	5	12,2	3,2	15222
4,7	3,2	6	2,1	7536
4,7	3	8	2	8907
4,8		8	1,7	9170
5	2,8	7,2	2,7	13137
5	3	6	2	5818
5	2,8	7	2,8	11310
5,2	2,5	6,5	2,5	5655
5,5		6,5	2	13082
6	2,1	6,2	2,2	8477
6	2	6	2	9331
6	2	6	2	11325
6	4	7	3,2	5472
6	4	7,5	2	10682
6	3	7	2	8598
6,5	4,5	8,5	3,3	5926
7,4		16	3	15128
8	4,5	10	3	10303
8	5	10	3	9383
9,4	2	6	3,8	5510
10	2	7	7	12420
10	3	8,5	3	5812
12	5	10	4	12267
12	3	11	4	14597
12	3,5	12	3,5	12397
12	3	9	3,5	13662
12	1,4	9,5		9181
13	2	11	4	5589
13	3	11	4	5941
14	4	13	9	11880
14	6	12	18	12538
14	3	10	4	10954
14	3	11		9260
15	5	10	5	8141
15	4	10	6	7800
15		10	7	5916
16	5	10	10	10867
16	5	10	4	12266
16	4	9	5	3980
16	4	9	4,5	12482
18	5	11	5	10724
18	2	7	5	11878
20		15	11	9165
20	6	14	10	5914
22,3	5,5		13	9190
23		22,5	16,5	11191
24	1,8	4	12	8985
24	3	8	17	10955
25	3	9,5	16,5	5970
25	3	9	18	5530
26	2	8	14	6057
26	2	6	16	8700
30	5	20	15	8662
32	2	6	16	6281
32,5	2,5	3,5	30	13505
40	15	35	30	6168
50	1	31	1	5275

Porous cord	D	Item code	Porous rectangle	A	B	Item code
	2	15391		4	4	15163
	3	15083		5	10	14962
	4	15106		8	3	14547
	6	15230		10	10	14859
	7	15214		15	15	14740
				16	10	14594

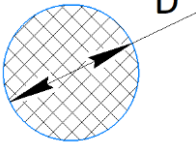
Cord	D	Item code
	1,5	5565
	2	6283
	2,5	7007
	3	7008
	3,2	4097
	3,5	7564
	4	5517
	4,5	10311
	5	10310
	5,5	5394
	6	5509
	6,5	12629
	7	5549
	8	6180
	8,5	14852
	9	6407
	10	5138
	10	14853
	11	5114
	12	5471
	14	4667
	15	5108
	16	8483
	18	15138
	30	9508
	35	9765
	40	5706
	41	5135
	50	8910

16	16	14144
18	12	15013
18	12	15355
20	10	14240
20	8,5	14900
20	18	14279
20	20	5639
22	18	14766
24	18	14601
25	5	14489
25	6	14774
30	13	14949
30	20	14538
30	15	14591
35	10	14589
35	30	14695
35	22	15456
40	25	14831
50	3	14263

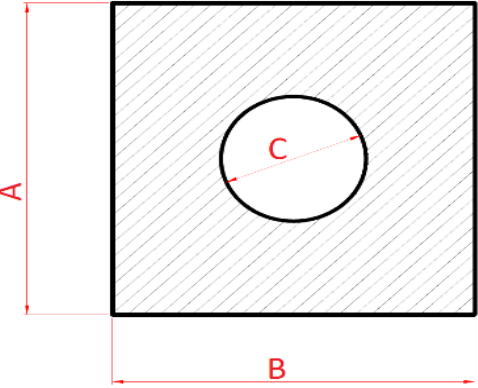
Rectangle with hole	A	B	C	Item code
	8	11	5	12459
	10	10	5	9670
	12	12	6	7188
	12	12	8	7189
	13	13	7	8769
	14	14	7	5529
	15	15	6	5626
	16	18	7	7000
	16	16	10	9677
	16	16	8	5299
	18	14	8	8746
	18	18	8	5625
	20	15	6	5626
	20	16	8	7992
	20	20	6	7322
	20	20	10	6277
	20	20	12	9676
	20	10	4	6003
	25	20	8	7455
	40	40	6	7323

Mushroom-shaped №1	A	B	C	Item code
	7	7	12	11121
	10	15	30	11124
	14	16	30	11138
	15	10	15	7410
	15	15	26	5784
	18		20	6106
	18	15	30	7860
	19	9	22	7021

Mushroom-shaped №2	A	B	C	D	Item code
	8	28	32	12	12261
	9,2	30	31	26	14546
	10	22	15	8,5	9292
	10	25	20	12	6567
	10	30	20	15	11124
	14	29	37	16	7424
	16	22	20	10	12494

L-Similar	A	B	C	D	Item code
	9,7	7,5	6	2	6063
	10	10,5	3	6	8673
	27	18	9	>	5728
	30	25	13	>	7491
	35	22	15	>	12947
	36	20	15	>	7770
	38	19	14	>	6248
	38	21	14	>	8116
	38	21	14	>	12794
	59	6	2	2	12890

* The ">" symbol indicates a sharp-angled profile

G-Similar	A	B	C	D	E	Item code
	4,5	4,5	5,5	8,5		6470
	6		8	10		11211
	6,5		6	10		6471
		11	8	11		15322
	7		7,5	11		5979
	8		11	11		13923
	6,5		9	11,8		13865
			12	13		5876
		9	6	16	15	11212
	10		15	20	17	11799
	16	16,5	17,5	21,5		6469
	15		15	22	15	8978
	13,7	11,9	12,1	22	12,1	5086
	15		15	22	15	8978

b- Similar	A	B	C	D	E	Item code
	9		10		12,7	15033
	10	8	11	13		8383
	13	10,5	12,5	18,5	14	7411
	14	9,5	12	17	12	7174
		7,2	8,4	13		5300

